

Прилог 2.1 за задатак A01 - A04
Објекат 1

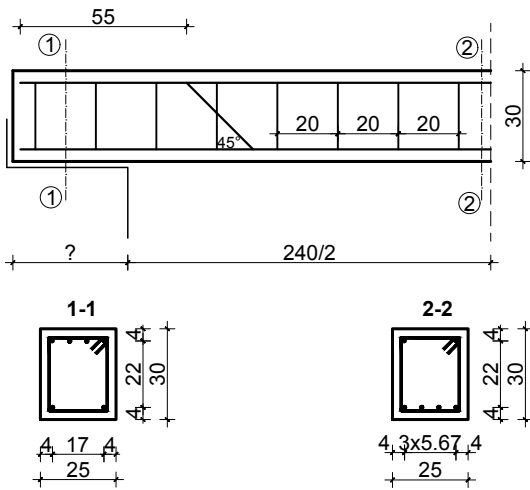

POS G1, POS G101

ГРЕДА POS G1, POS G101

- главна арматура (RA) R Ø14
- монтажна арматура (RA) R Ø12
- узенгије (GA) U Ø8/20

POS S1

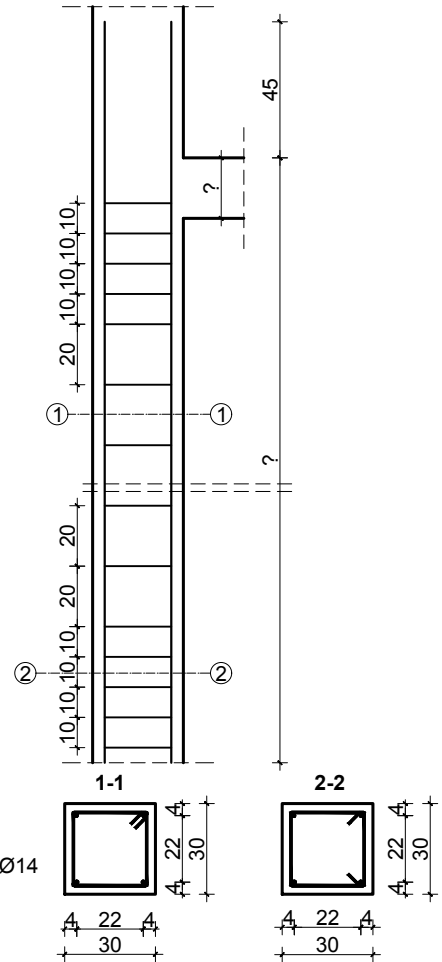

СТУБ POS S1

- подужна арматура (RA) R Ø14
- узенгије (GA) U Ø6

POS G2, POS G102

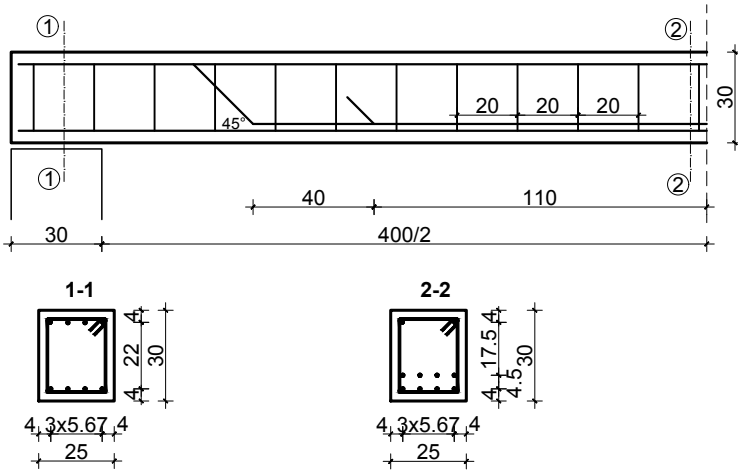

ГРЕДА POS G2, POS G102

- главна арматура (RA) R Ø14
- монтажна арматура (RA) R Ø12
- узенгије (GA) U Ø8/20

POS S101

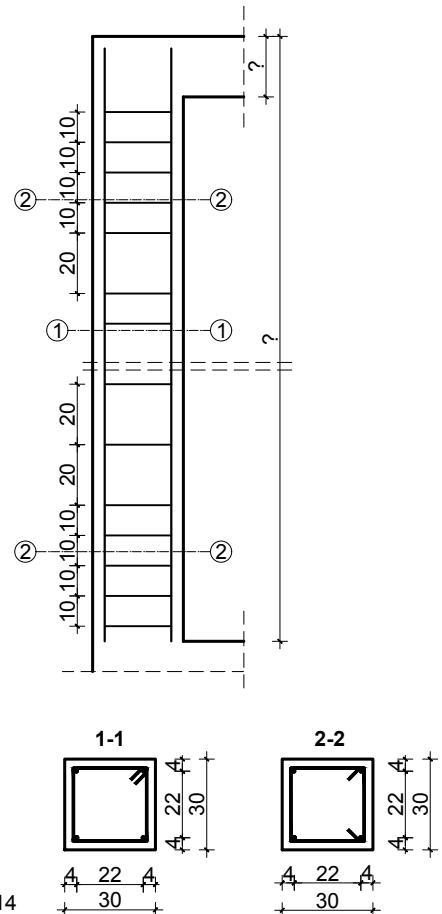

СТУБ POS S101

- подужна арматура (RA) R Ø14
- узенгије (GA) U Ø6

Прилог 2.2 за задатак A01-A04
Објекат 2

POS 1 i POS 101

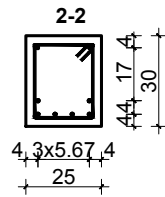
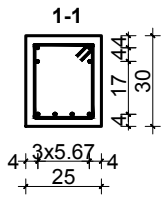
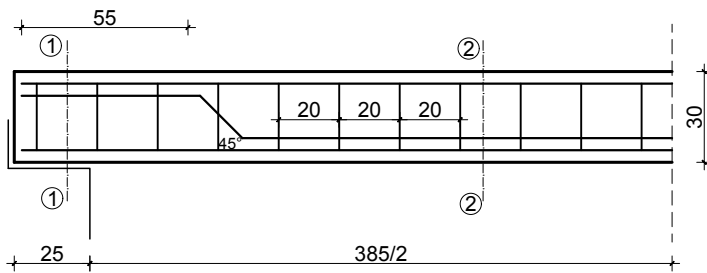

**GLAVNA
6RØ14
MONTAŽNA 2RØ12
UZENGIJE UØ6/20**

POS 2 i POS102

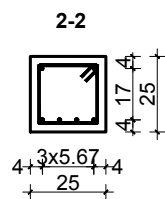
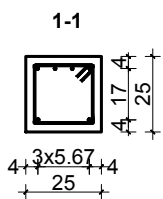
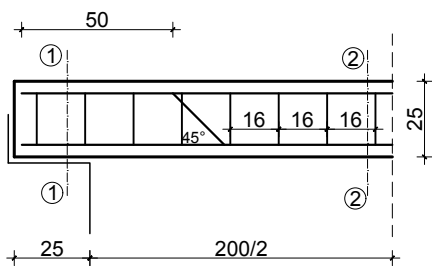

**GLAVNA 4RØ12
MONTAŽNA 2RØ12
UZENGIJE UØ6/16**

POS 1 i POS 101

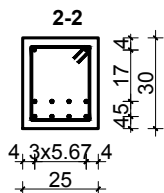
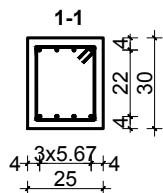
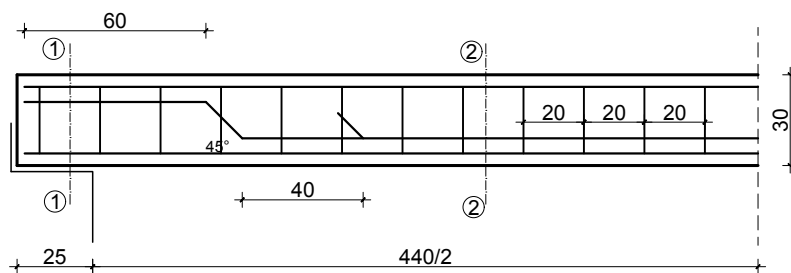

**GLAVNA 8RØ14
MONTAŽNA 2RØ12
UZENGIJE UØ6/20**

POS 2 i POS102

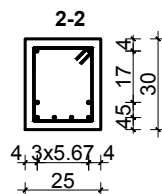
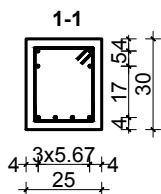
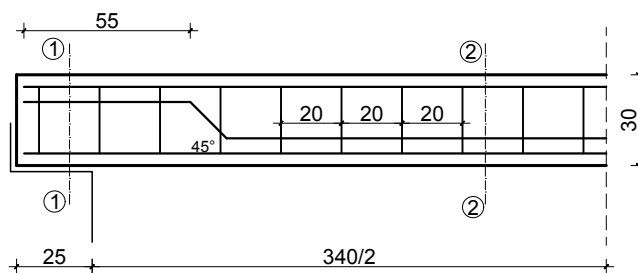

**GLAVNA 6RØ14
MONTAŽNA 2RØ14
UZENGIJE UØ6/20**

POS 3 i POS103

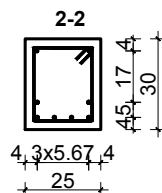
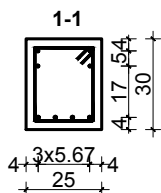
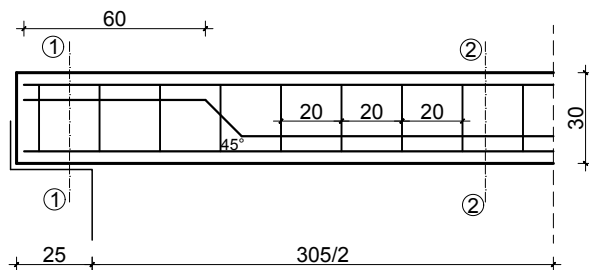

**GLAVNA 6RØ14
MONTAŽNA 2RØ12
UZENGIJE UØ6/20**

PRILOG 2 I 3 (STUB 25x25)

STUB PRIZEMLJE

POS S1

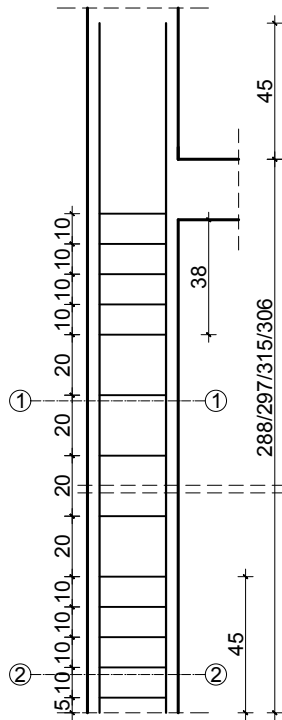

STUB SPRAT
POS S1 i S2

1-1

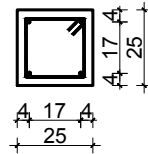

2-2

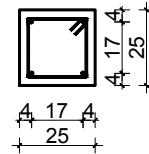

POS S2

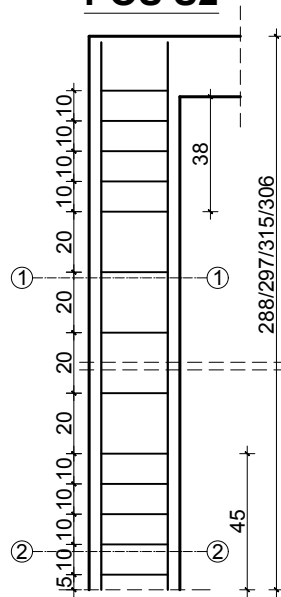

Прилог 2.4.1 за задатак A05 и A06
Стан 1 и стан 2 - типска етажа

POS 1 i POS 101

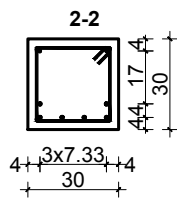
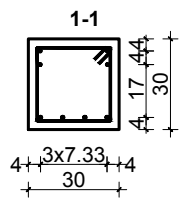
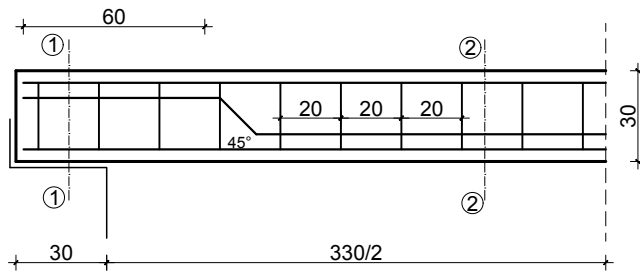

**GLAVNA 6RØ14
MONTAŽNA 2RØ12
UZENGIJE UØ6/20**

POS 2 i POS102

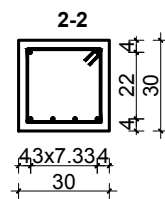
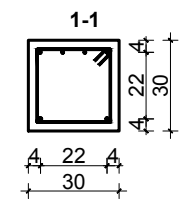
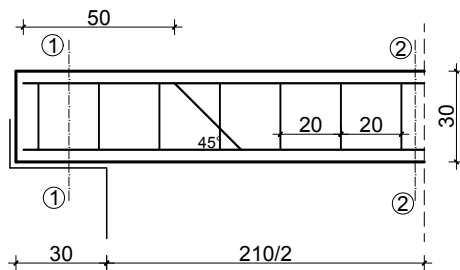

**GLAVNA 4RØ14
MONTAŽNA 2RØ12
UZENGIJE UØ6/20**

Прилог 2.4.2 за задатак A05 и A06
Стан 1 и стан 2 - типска етажа

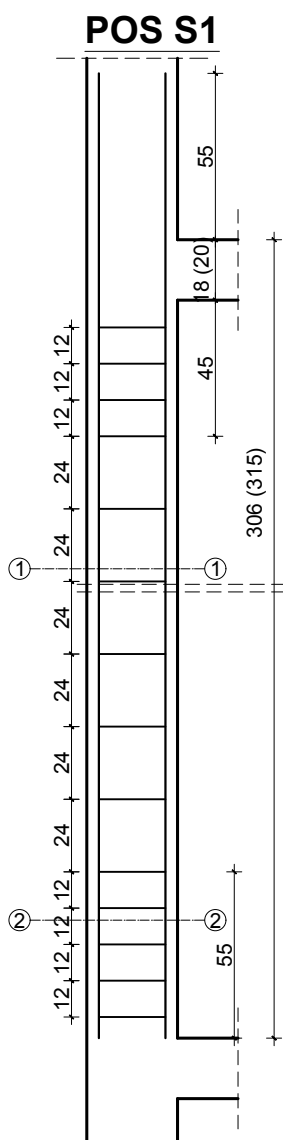

STUB 30x30
PODUŽNA ARMATURA 4RØ16
UZENGIJE UØ6

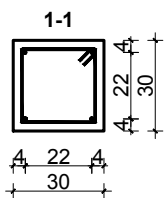

POS S1

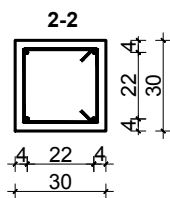

POS S1